

Advanced film dosimetry for a UK brachytherapy audit

Tony Palmer

Lead Scientist Medical Physics, Portsmouth Hospitals NHS Trust, UK
University of Surrey, UK
Institute of Physics and Engineering in Medicine (IPEM)

A story....

- ... A desire to audit brachytherapy
- ... The search for a suitable dosimeter
- ... Gafchromic film comes to the rescue
- ... UK brachytherapy audit



Portsmouth, England



HMS Victory, 1778



Spinnaker Tower, 2005



Queen Alexandra Hospital, Portsmouth
Hospitals NHS Trust, 2009

Disclosures

- Thanks to Ashland Inc. who provided EBT3 Gafchromic film and funding for today's presentation
- Thanks to IPEM for providing funding of the audit

Contents

- ❑ Need for audit & dosimetric audit in brachytherapy
- ❑ Selection of dosimeter (EBT3 film)
- ❑ Development of film methodology
- ❑ Evaluation in brachytherapy
- ❑ Design of test phantom
- ❑ Results of UK HDR brachytherapy dosimetry audit
- ❑ Conclusions

Dosimetry audit

- ❑ The need for clinical audit
- ❑ The need for HDR brachytherapy dosimetry audit
- ❑ Errors and incidents in brachytherapy
- ❑ Other brachytherapy audits
- ❑ Dosimetry audit in UK

The value of external audit in physics

- ❑ Complementary to routine local QC schedules and procedures
- ❑ Objective review of processes
- ❑ Promotes reflection of 'local routine practice'
- ❑ Fully independent dosimetry method
- ❑ Access to specialist phantom or dosimeters
- ❑ Evidence of quality review
- ❑ Additional level of security
- ❑ Major errors have been detected by external audit

The value of external audit in physics

- ❑ Complementary to routine local QC schedules and procedures
 - ❑ Objective review of processes
 - ❑ Promotes reflection of 'local routine practice'
 - ❑ Fully independent dosimetry
 - ❑ Access to specialist phantom
 - ❑ Evidence of quality review
 - ❑ Additional level of security
 - ❑ Major errors have been detected by external audit
- In brachytherapy...

 - ❑ local QC sometimes only straight catheters,
 - ❑ 'Historic practice' has momentum,
 - ❑ Sometimes less investment/focus,
 - ❑ Lack of prior audit/review
-

The need for clinical dosimetry audit



“ a way to find out if healthcare is being provided in line with standards ” 2014

- ❑ Mandatory in many countries
- ❑ Advocated by majority of physicists to:
.....fulfil legal requirement, for QA of clinical trials, best-practice, minimise risk of error, avoid litigation, add security.....

The need for clinical dosimetry audit

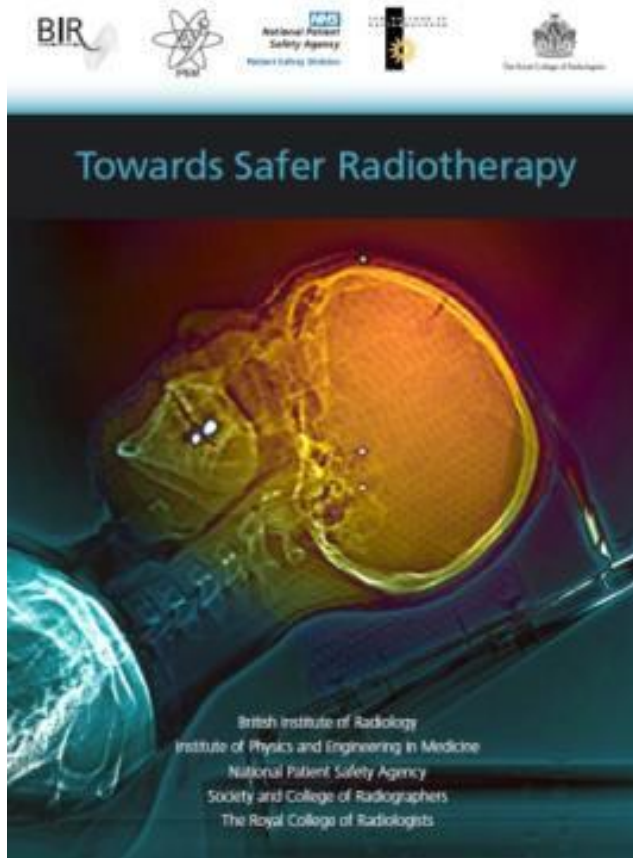

“ dosimetric audit can provide valuable opportunities to ensure safe delivery of radiotherapy ” 2008

The need for clinical dosimetry audit

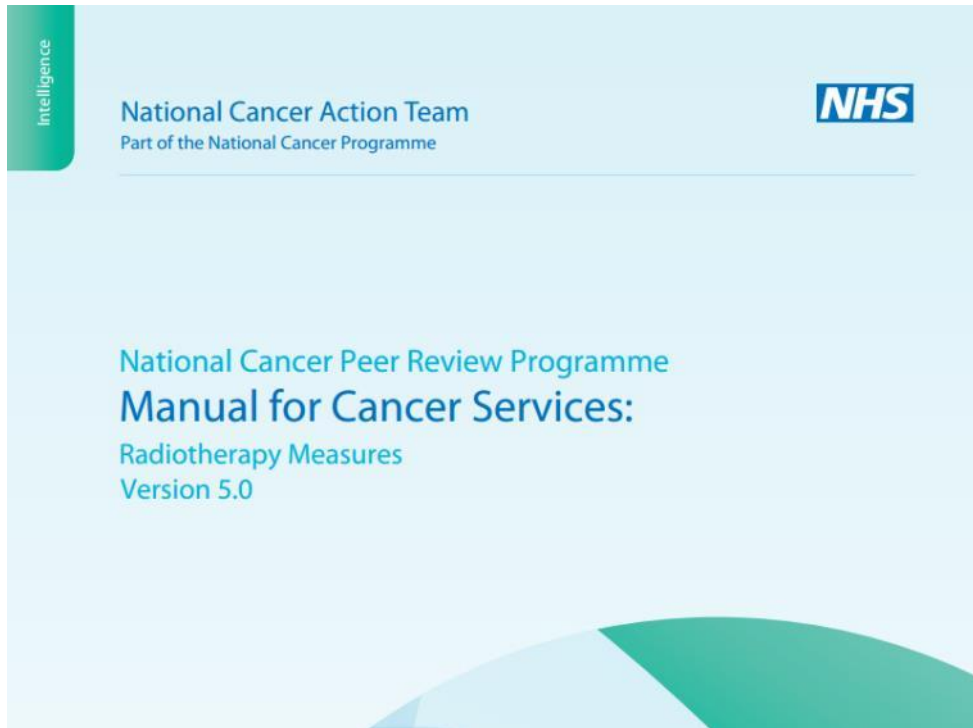

“ the department should have taken part in the external quality control programme ” 2013

The need for brachytherapy dosimetry audit



B01/S/b

2013/14 NHS STANDARD CONTRACT
FOR BRACHYTHERAPY AND MOLECULAR RADIOTHERAPY (ALL AGES)

SECTION B PART 1 - SERVICE SPECIFICATIONS

Service Specification No.	B01/S/b
Service	Brachytherapy and Molecular Radiotherapy (All Ages)

© NHS Commissioning Board, 2013
The NHS Commissioning Board is now known as NHS England

“ to ensure services being delivered offer high quality brachytherapy to patients... provider must participate in the national inter-departmental dosimetry audit programme ” 2013

The need for reassurance – external beam

The Local
FRANCE'S NEWS IN ENGLISH

February 12, 2014

[Register](#) · [Sign in](#)
[About us](#) · [Advertise](#)



Doctor Michel Aubertel (left) at the court house in Paris. He was one of three doctors jailed over deadly radiation overdoses given to patients. Photo Thomas Samson/AFP

Doctors jailed over cancer radiation scandal

Published: 30 Jan 2013 16:35 GMT+01:00

Updated: 30 Jan 2013 16:53 GMT+01:00

A French court on Wednesday sentenced two doctors and a radiophysicist to 18 months in prison for their role in radiation overdoses given to nearly 450 cancer patients.

France, 2004. Court case 2013.

Wedge commissioning error.

Negligence in installation of new software and training planning staff.

2 doctors & 1 physicist charged with manslaughter, “failure to help people in danger & destroying evidence”.

Recommended peer review and audit, with adequate physics support.

The need for reassurance – brachytherapy

- ❑ Relatively simple process of HDR dose delivery (position and time), but masks the complexity of modern brachytherapy:
 - ❑ 3D image-based, 3D target and OARs, inverse planning optimisation
 - ❑ Difficult dosimetry, high dose gradients, large dose ranges, small scales
 - ❑ The fallibility of software/hardware/physicist



HDR brachytherapy errors

The Sydney Morning Herald

INDEPENDENT. ALWAYS.

smh.com.au
The Sydney Morning Herald

[Home](#) > [National News](#) > Article

Critically ill received wrong radiation therapy due to human errors: review

By Ruth Pollard
September 12, 2003

Human error was to blame for radiation therapy being delivered to the wrong spot in nine critically ill patients at Prince of Wales Hospital, an independent review released yesterday confirmed.

A computer calculation error - discovered several weeks ago - led to a "geographical miss" to the targeted site, the hospital's director of medicine, John Dwyer, said.

Mr Dwyer said the brachytherapy treatment was being delivered via a flexible catheter to ease the suffering of patients who were close to death.

"It does not appear that we did as much harm as was potentially possible, and I don't believe any patient suffered because of our mistake. However, we recognise that was good luck, not good management."

Professor Dwyer described the error as a "major system failure" and said the hospital had implemented a protocol that would ensure the treatment computer was reprogrammed with each use.

HDR brachytherapy errors

Australas Phys Eng Sci Med (2011) 34:529–533
DOI 10.1007/s13246-011-0095-z

TECHNICAL PAPER

Lessons learned from a HDR brachytherapy well ionisation chamber calibration error

Claire Dempsey

Received: 4 April 2011 / Accepted: 8 August 2011 / Published online: 20 August 2011
© Australasian College of Physical Scientists and Engineers in Medicine 2011

Abstract The outcomes of a recent brachytherapy well-type ionization chamber calibration error are given in the hope that other brachytherapy treatment centres may better understand the importance of each entry stated in a well chamber calibration certificate.

HDR brachytherapy errors

The Asahi Shimbun

AW Asia & Japan Watch

Hospital delivers radiation to wrong spots in 100 cancer treatment cases

🕒 December 26, 2013

ISEHARA, Kanagawa Prefecture--One hundred patients received radiation treatments for cancerous tumors for the wrong parts of their bodies, Tokai University Hospital disclosed Dec. 25.

It said the errors were found in cases involving brachytherapy, a procedure in which a radioactive source is placed into or adjacent to the area requiring treatment.

In the mistakenly treated cases, the radioactive substances were placed about 3 centimeters from the area they were intended to target. The hospital said the errors were caused by a problem with medical devices used in the procedure.

HDR brachytherapy errors

Urgent Field Safety Notice



Subject: Mispositioning of source
 Date of Notification: March 17th 2014

Summary

The automatic correction of the dwell position in the [redacted] applicator has to be improved.

Description of technical problem

When the source is pushed out to the first dwell position, the cable will be having a 'snaking' effect, [redacted]. Therefore the treatment position of the second dwell point might deviate from the planned position with a difference of maximum 2-3 mm in the direction of the tip. This difference remains for all further dwell positions in respect to what is planned.

Planned dwell positions, 5 mm stepsize



Actual dwell positions; pos. 1 at correct position



Actual dwell positions; pos. 2 and further are 2-3 mm more to the (wire is only shown for the 2nd dwell position)



	Dose difference with 2 mm shift	Dose difference with 3 mm shift
Manchester points A	+0.5%	+0.6%
Bladder point – Central Point	-2,3%	-8,0%
Bladder point – ICRU point	-3,4%	-12,0%
Rectum point – ICRU point	+2.6%	+3.9%

Previous HDR brachytherapy audits

- ❑ Lack of ‘advanced’ end-to-end dosimetry audits in clinical brachytherapy physics practice.

“...to date, dosimetric audits of HDR facilities have not been conducted despite the high risks associated with these treatments due to the challenges presented by measuring doses in steep dose gradients”

(Haworth et al 2013)

Previous HDR brachytherapy audits

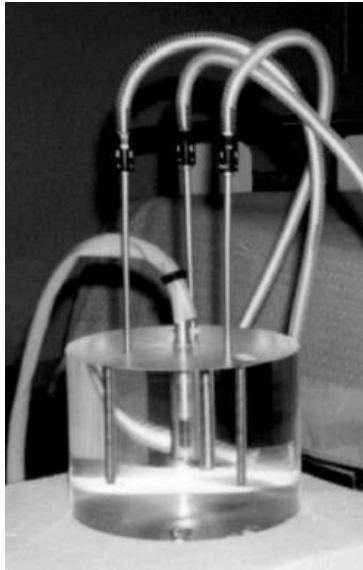

Elfrink *et al* (2001)
Ionisation chamber,
Netherlands and Belgium

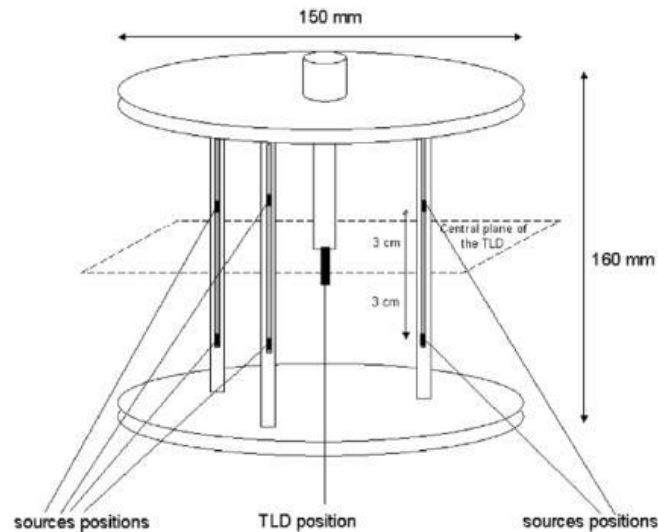

Roue *et al* (2007),
TLD, EQUAL-ESTRO
mailed audit

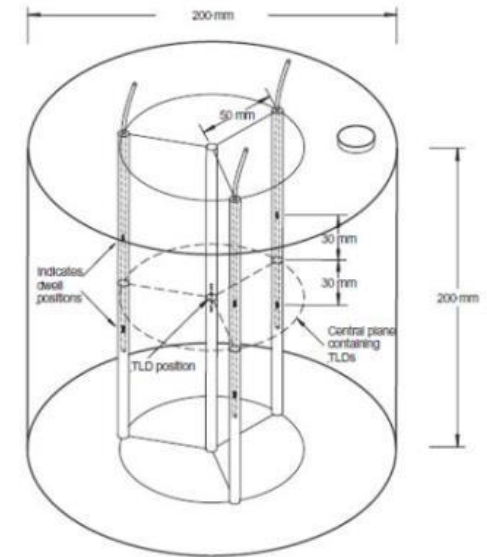

Haworth *et al* (2013),
TLD, Australian audit

Previous HDR brachytherapy audits



Tedgren *et al* (2008)
Well chamber, Sweden

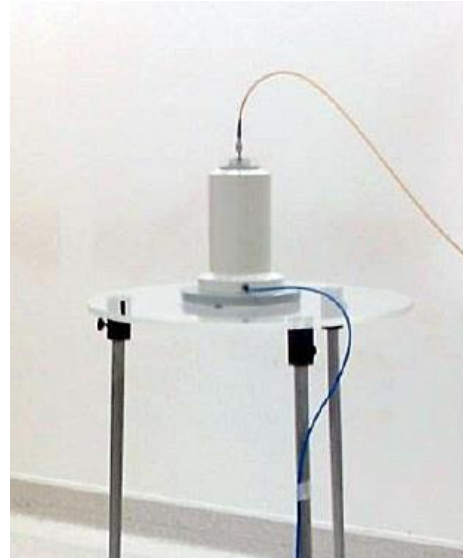

Lee *et al* (2013-14, in progress)
Well chamber intercomparison, UK

Previous HDR brachytherapy audits

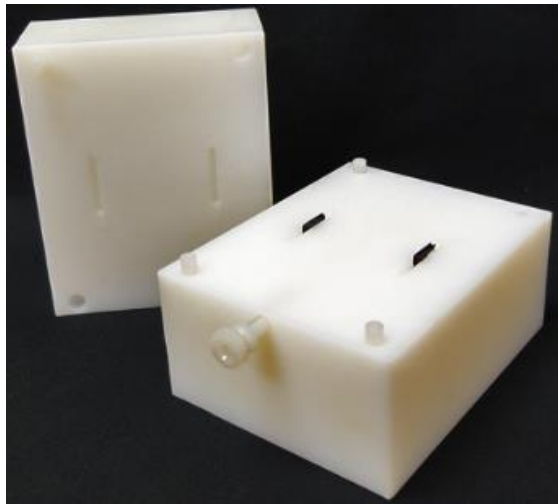

Casey *et al* (2011)
nanoDot optically stimulated
luminescence, mailed, USA

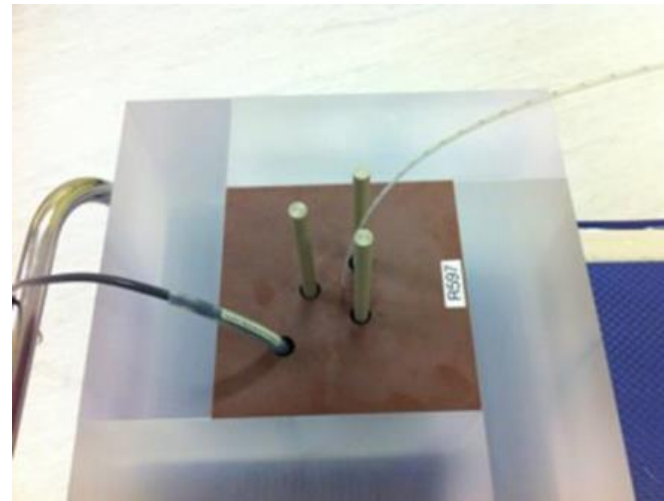

Diez, Aird *et al* (2013-14, in progress)
Alanine and Farmer chamber, UK

Well developed dosimetry audit in UK

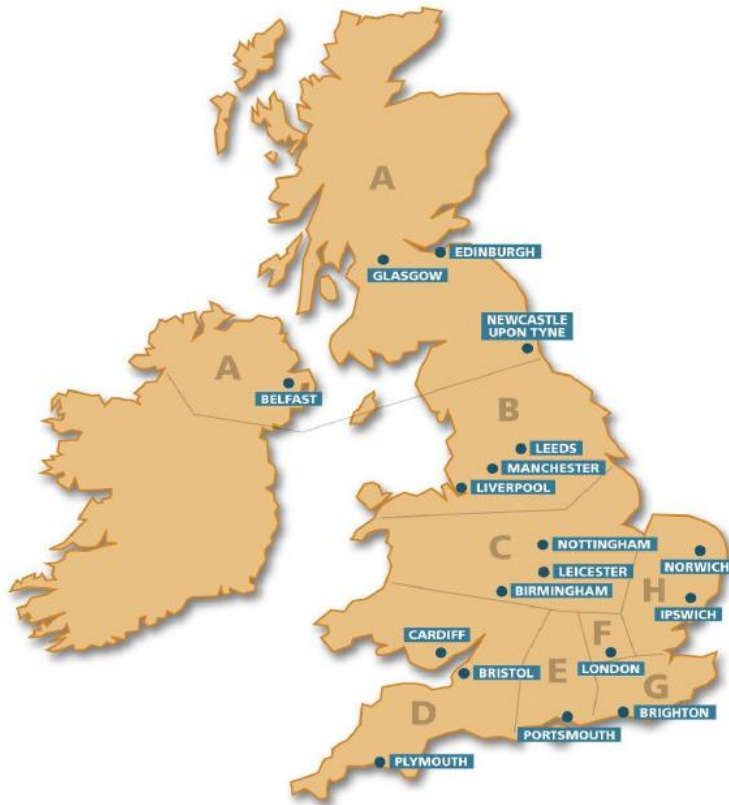

- ❑ 8 regional interdepartmental audit groups
- ❑ Clinical trials audits by NCRI-funded RTTQA group
- ❑ Specialist national audits
 - ❑ MV 2008
 - ❑ Electron 2009
 - ❑ IMRT 2010
 - ❑ Rotational 2013
 - ❑ Electronic brachytherapy 2013

UK national brachytherapy audit - Aims

- ❑ Undertake a **UK national audit** of HDR brachytherapy physics
- ❑ Aim to detect any **clinically significant** issues in dosimetry or physics processes
- ❑ Implement an '**end-to-end**' **system audit**, including imaging and treatment planning system calculation
- ❑ Measure doses around clinical **brachytherapy applicators** not straight catheters
- ❑ Measure **dose distribution** in 3D or multi-2D, not just point dose

Candidate dosimeters

- ❑ Review of dosimeters used in literature
- ❑ Other options investigated
- ❑ Selection of EBT3 and triple-channel dosimetry

Dosimetry options

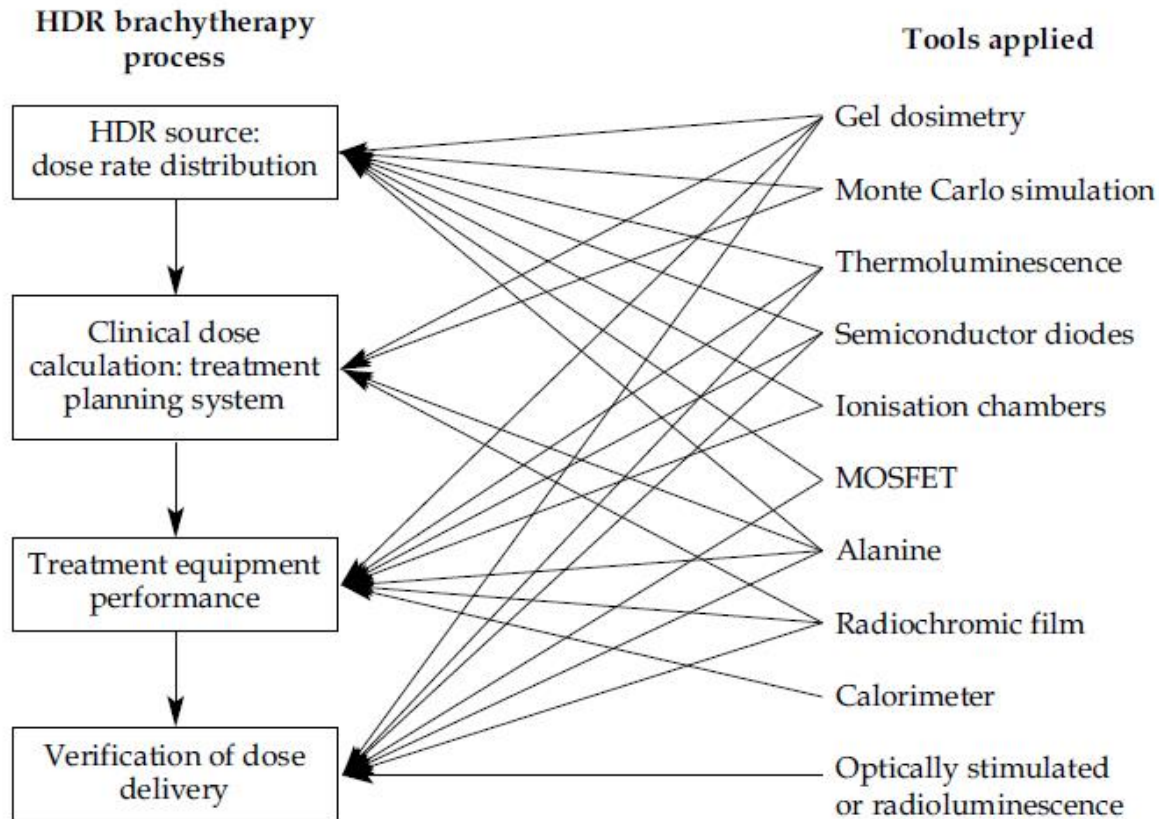

Candidate dosimeters

- ❑ Existing 'standard' dosimeters not ideal for brachy audit application: physical size, dose range, water equivalence, energy response, etc
- ❑ High spatial resolution point measurement
 - ❑ optical fibre
- ❑ Multi-plane 2D measurement
 - ❑ film (EBT3[®] with triple-channel dosimetry)
- ❑ Full 3D measurement
 - ❑ gel/plastic dosimeter (Presage[®])

Candidate dosimeters: Optical fibre

Ge-doped SiO_2 $6\mu\text{m} \times 5\text{ mm}$ with thermoluminescent (TL) readout

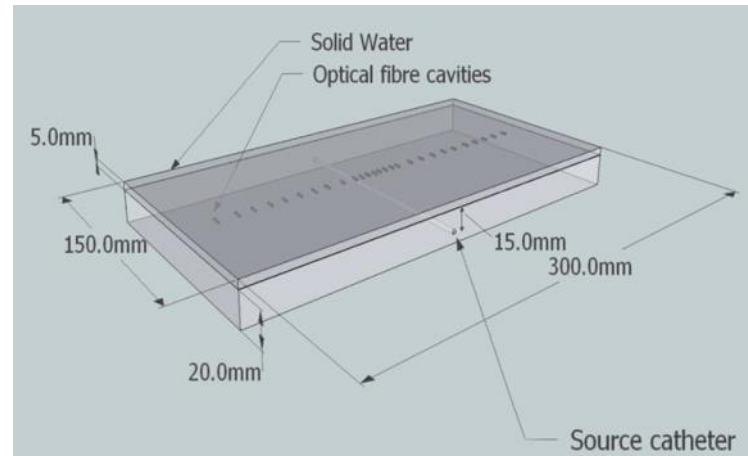
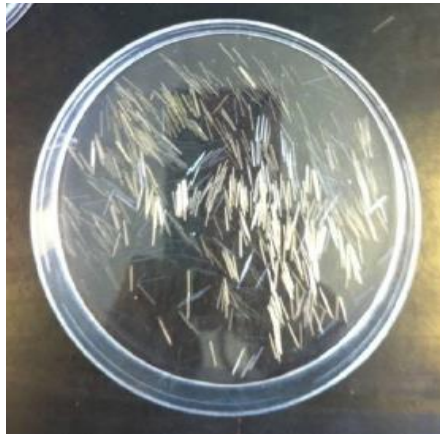

Candidate dosimeters: EBT3 Gafchromic film

EBT3 film, 3-colour channel scanner readout, FilmQAPro™

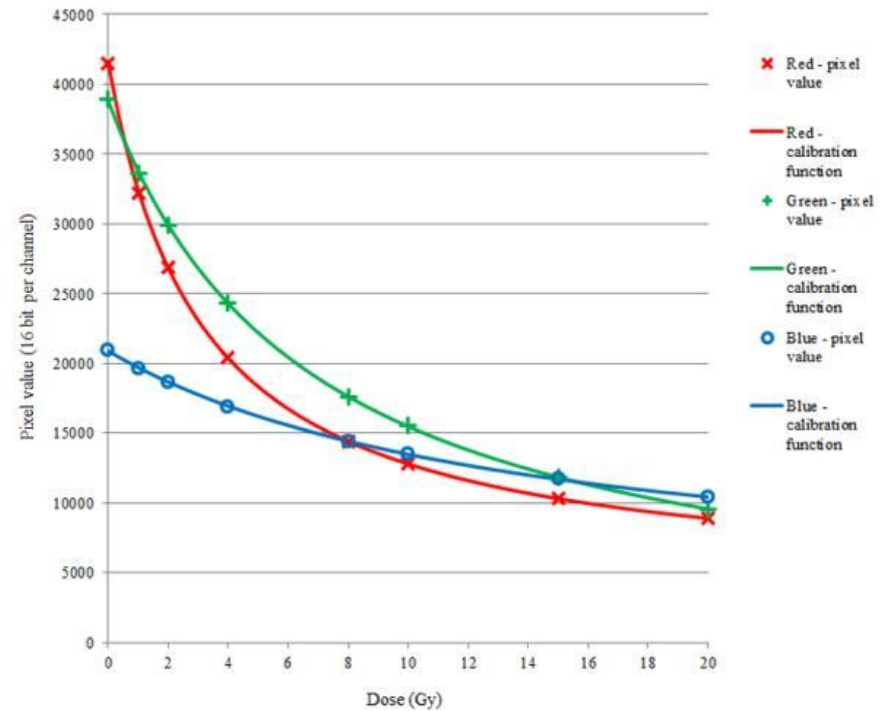
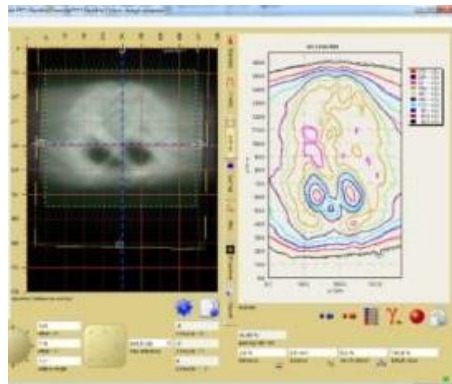

Candidate dosimeters: Presage[®]

Polyurethane with radiochromic material, optical CT readout

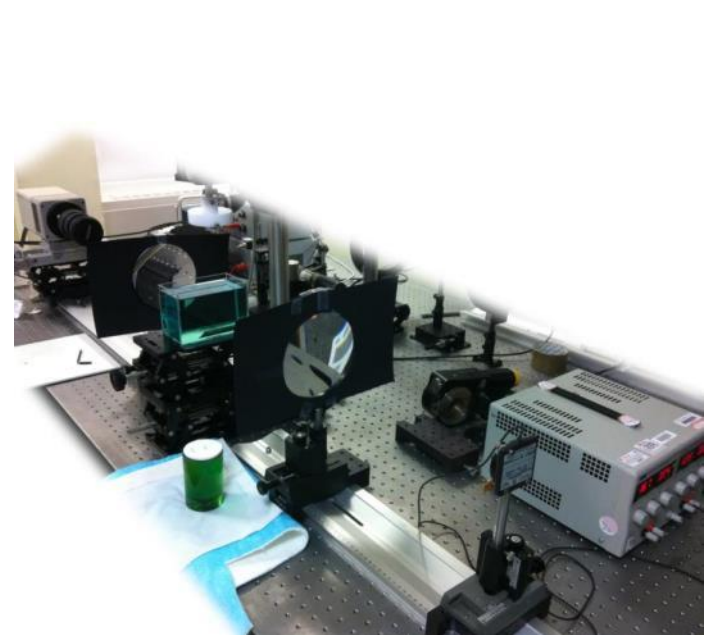
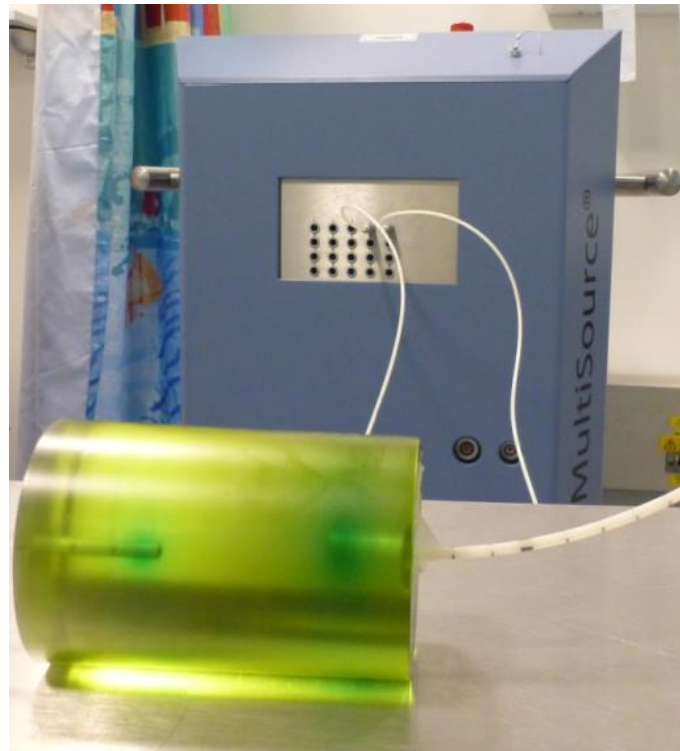

Evaluation of dosimeters

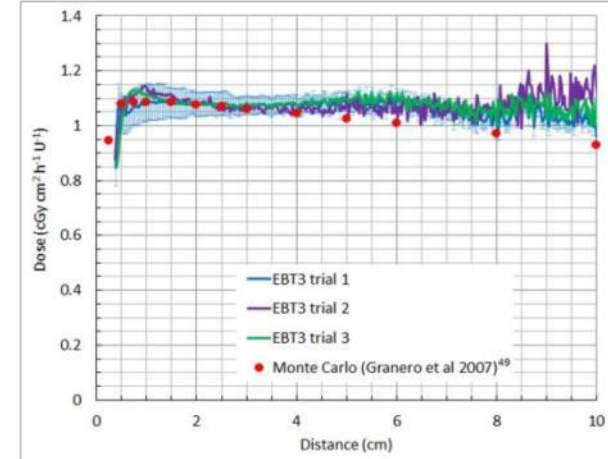
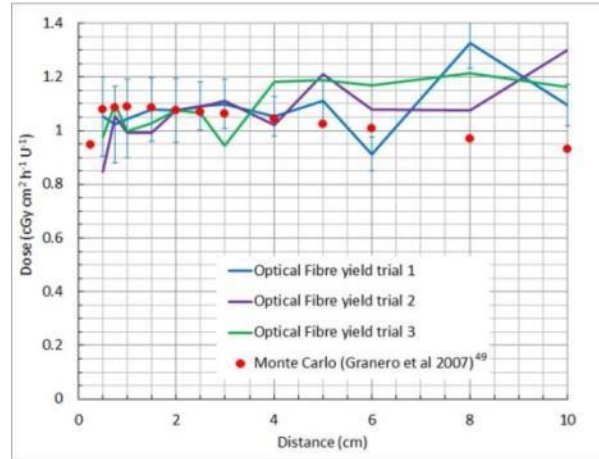
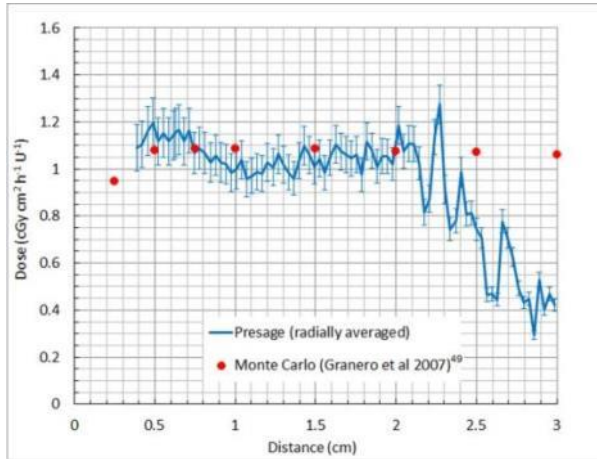

Palmer et al. Comparison of methods for the measurement of radiation dose distributions in HDR brachytherapy, *Med. Phys.* 2013;40(6)061707-1-11

Evaluation of dosimeters

	Cost	Availability	Ease of use and analysis	Dosimetric data quality
Optical fibre TL (point detector)	++	-	-	+/-
Gafchromic EBT3 [®] film (2D detector)	++	++	++	++
Presage [®] radiochromic plastic (3D detector)	+/-	-	-	+

- ❑ 2D film provided high spatial resolution without causing data paralysis (3D), was cheap, easy to obtain and use, had excellent dose response & dynamic range for brachy, water equivalent, can use in water, cut to size, etc

Development of film method

- ❑ Scan methodology
- ❑ Film considerations
- ❑ Evaluation of film dosimetry characteristics
- ❑ Evaluation of triple-channel dosimetry

Gafchromic film dosimetry methodology

- ❑ Care required in aspects of film dosimetry
 - ❑ AAPM TG-55 Radiochromic film dosimetry. *Med. Phys.* 25 1998

- ❑ Triple-channel technique with dose linear scaling in FilmQAPro[®] makes film dosimetry relatively easy and improves accuracy
 - ❑ Micke et al. Multichannel film dosimetry with nonuniformity correction. *Med. Phys.* 38 2011
 - ❑ Lewis et al. An efficient protocol for radiochromic film dosimetry combining calibration and measurement in a single scan. *Med. Phys.* 39 2012

Triple-channel film dosimetry

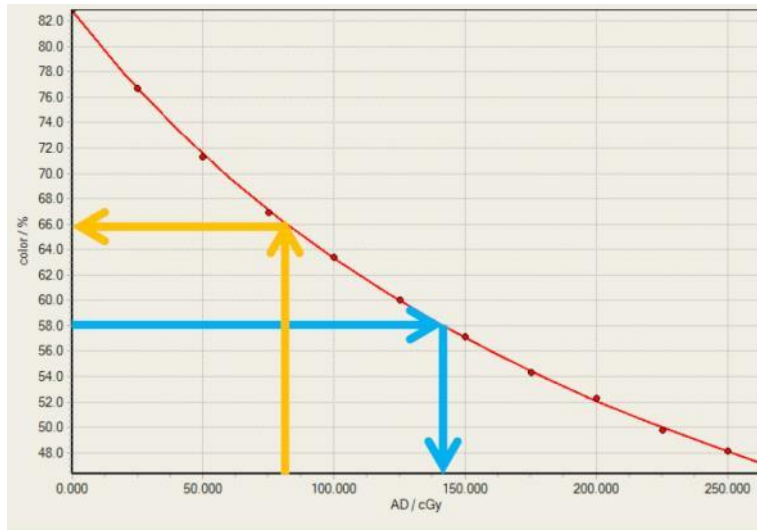

Single-channel dosimetry

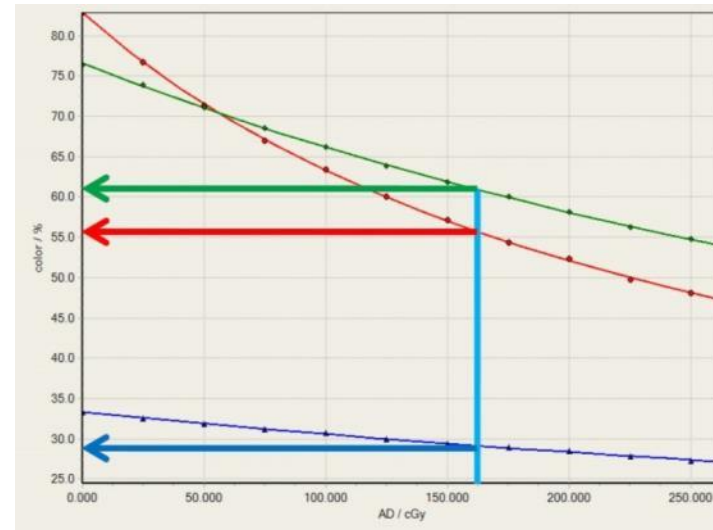

Triple-channel dosimetry

$$C_{\text{scan}} = C(\text{Dose}) + \Delta C(\text{disturbance})$$

- True dose is not a function of colour channel.
- Separate dose dependant and dose independent parts

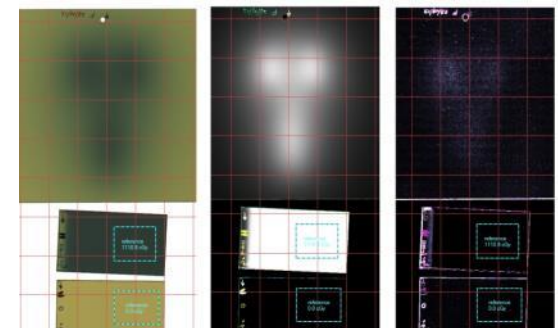

Dose linear rescaling in FilmQAPro

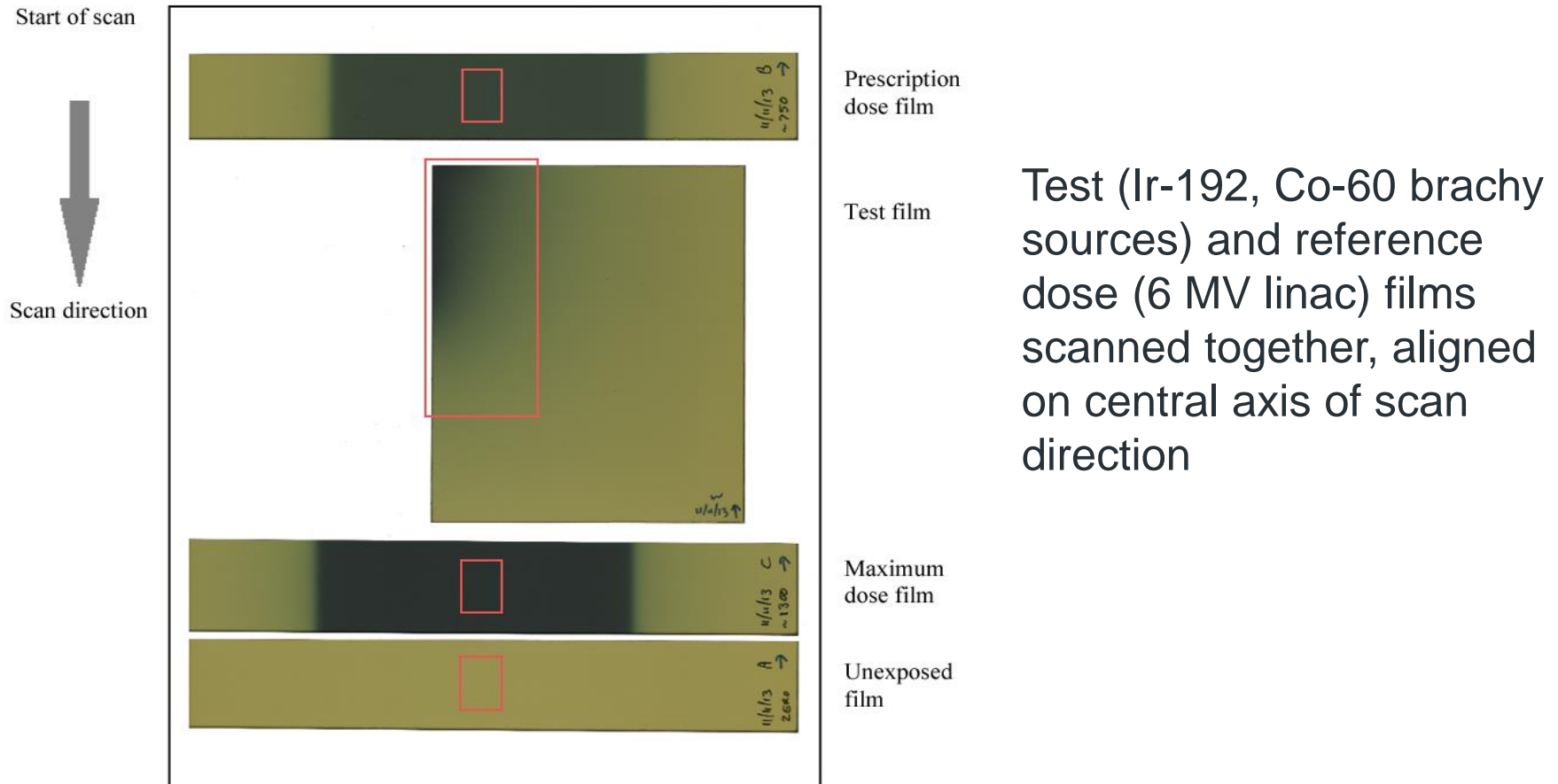

Palmer et al. Evaluation and implementation of triple-channel radiochromic film dosimetry in brachytherapy, *J. Appl. Clin. Med. Phys* 2014;15 (in press)

Film curvature at scanning

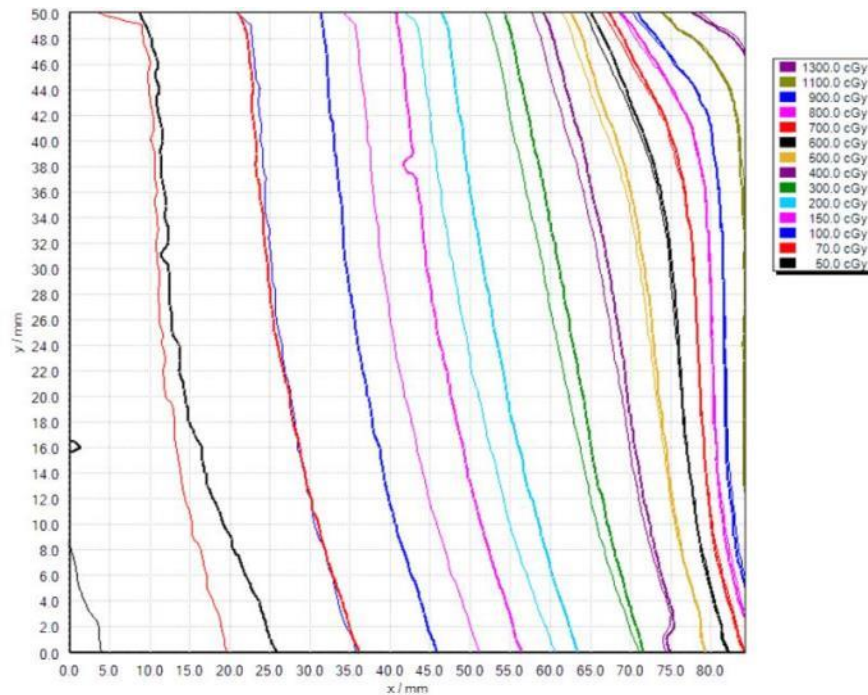
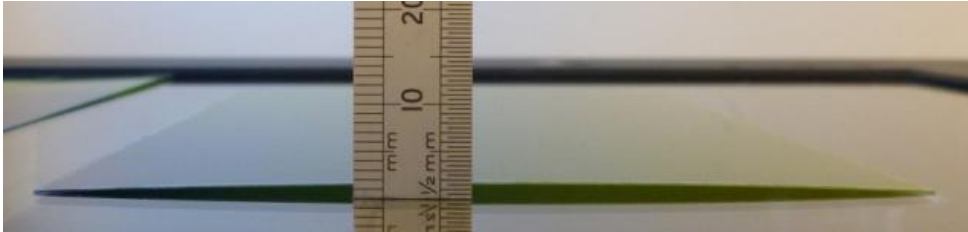

Small size films may curl at scanning; significant error possible (Callier-type effect).

Mitigate with glass plate (with EBT3) and/or triple-channel dosimetry

Post-exposure – audit timing consideration

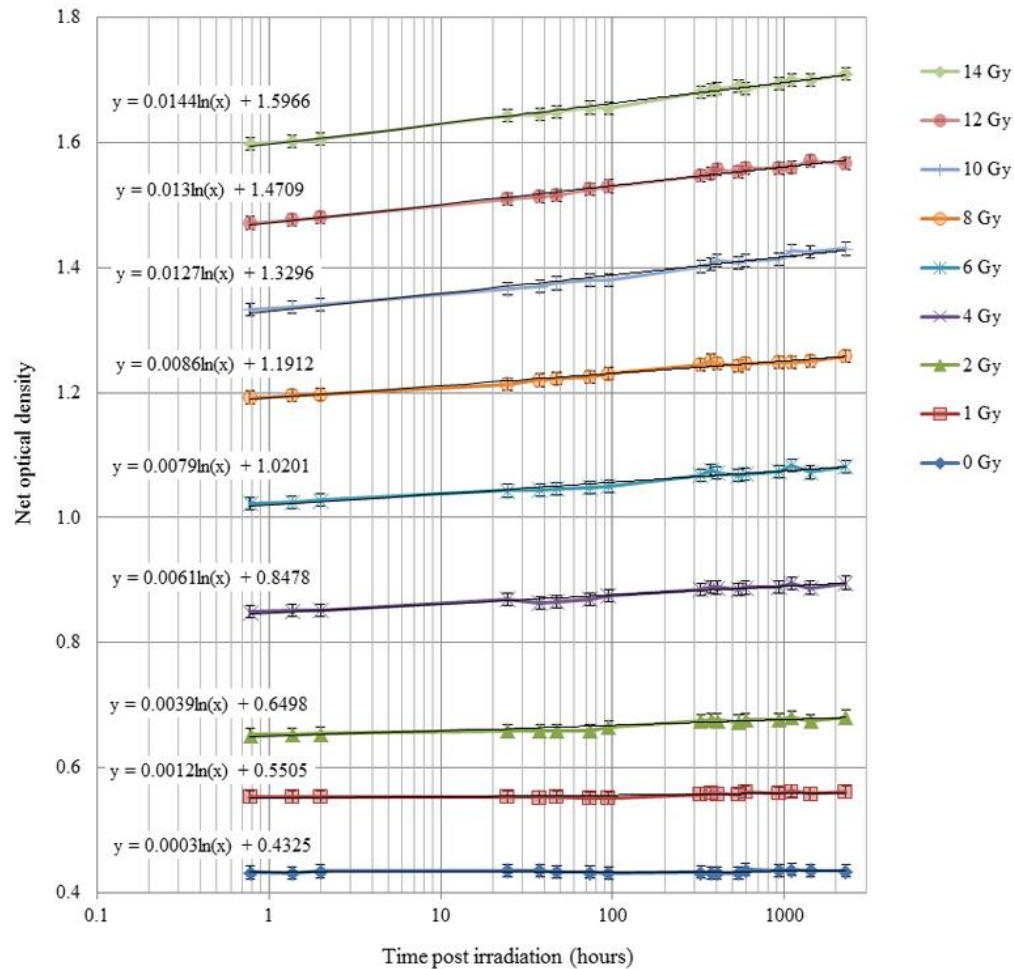

Darkening continues as $\log(\text{time})$ – important for audits, control of timescale

Often incorrect assumption in literature full darkening after 12-24 hours

Film surface perturbations – triple-channel

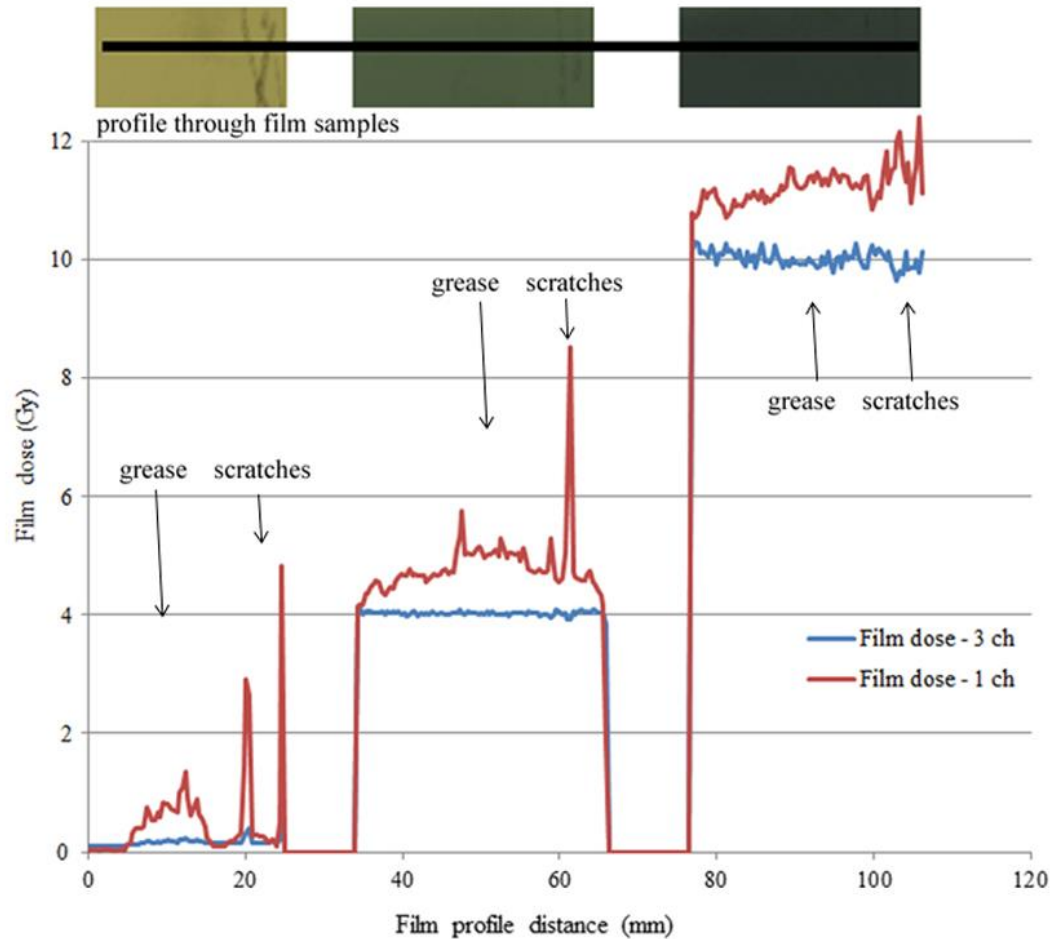

Mitigation of surface perturbations with triple-channel dosimetry.

Easy film handling.

Lateral scanner position – triple channel

EBT3 film polarises light in scanner, signal changes with position on scanner plate, mitigated with triple-channel dosimetry

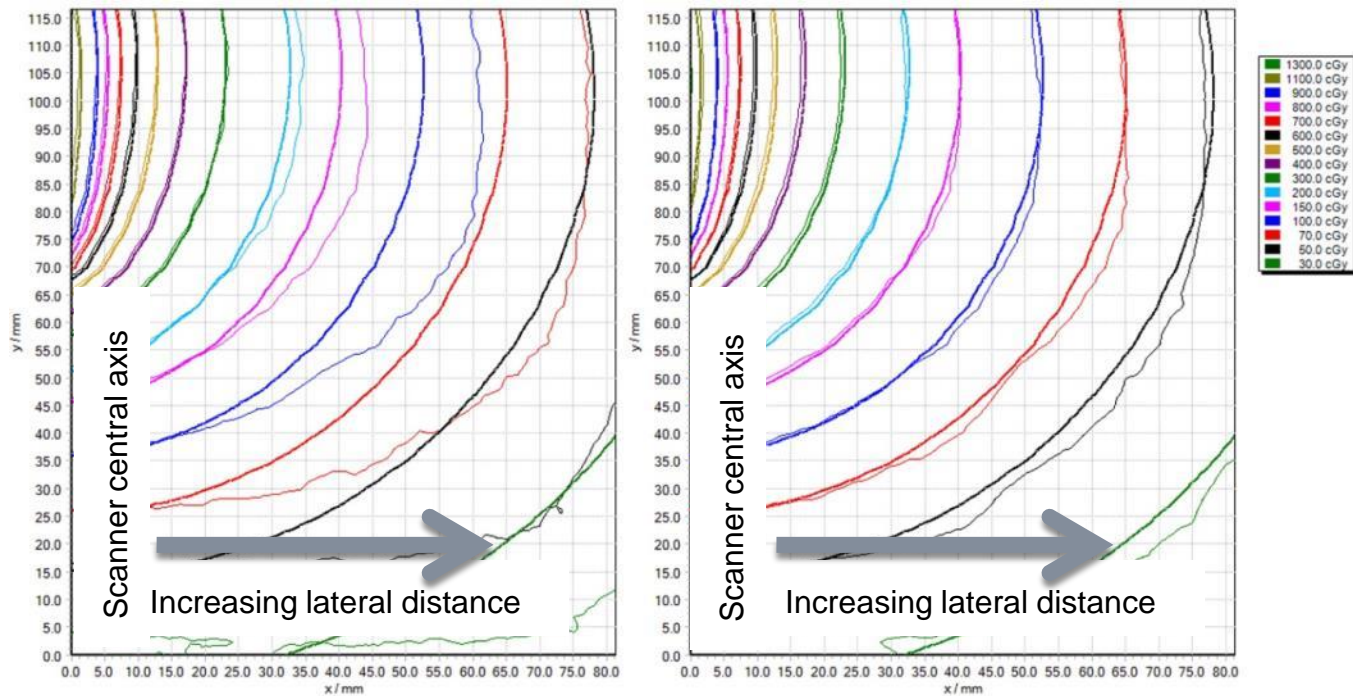

Single-channel dosimetry

Triple-channel dosimetry

Brachytherapy test applications

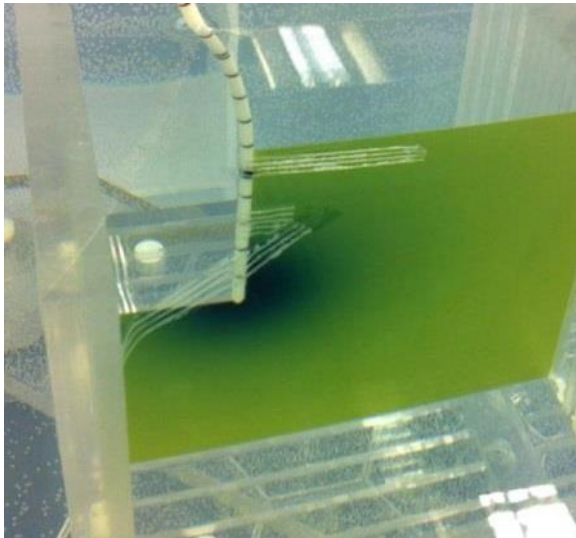

Single source dwell

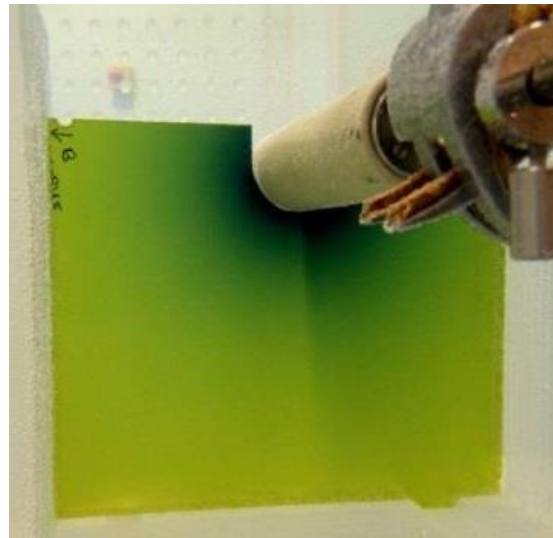

Shielded cylinder
applicator

Evaluation for Brachytherapy

- ❑ Experimental point source
- ❑ Experimental brachy dose distributions
- ❑ Theoretical confirmation, Monte Carlo calculations

Radial film dose from single HDR source

Film measured dose v Monte Carlo calculated

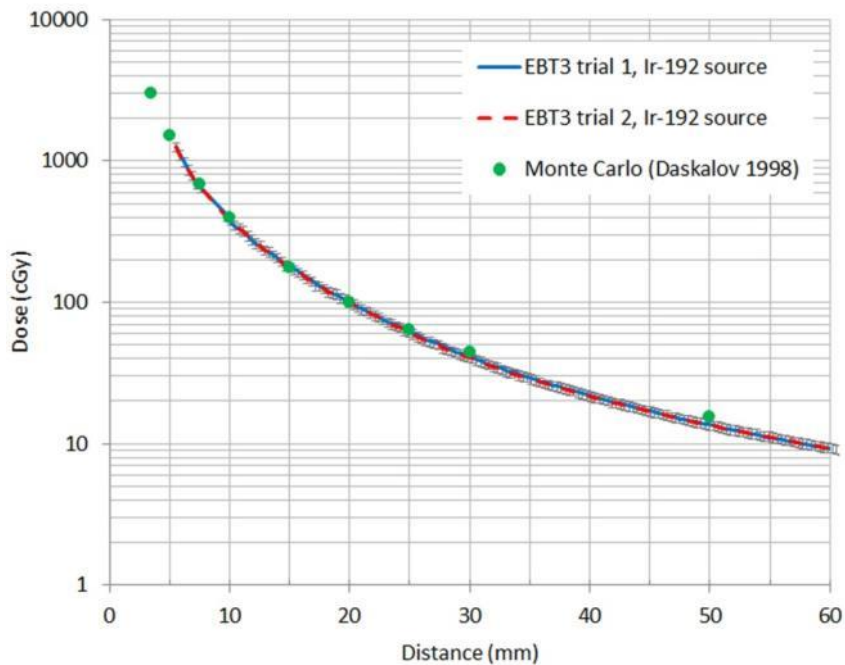

Ir-192 source

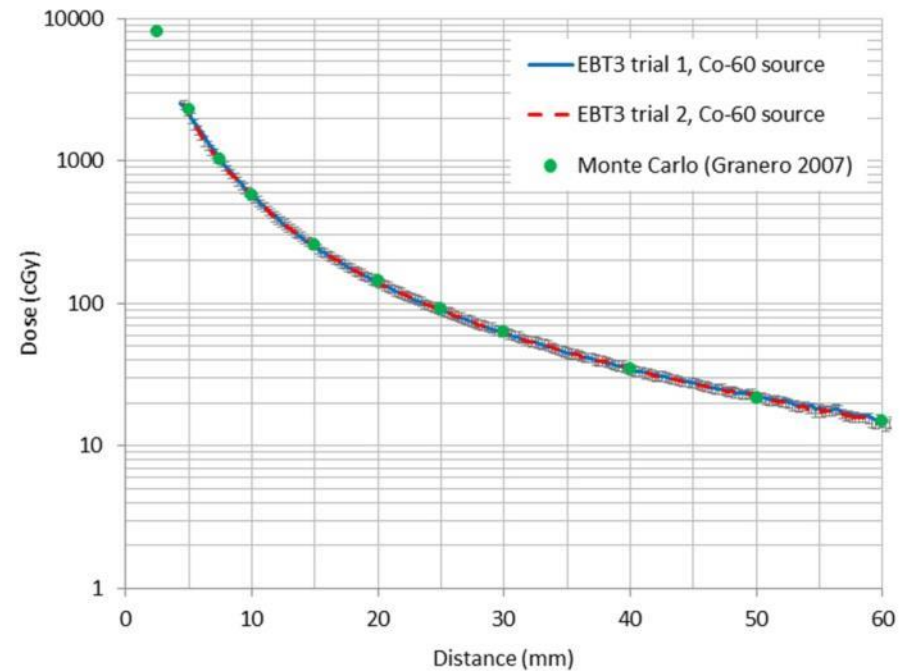

Co-60 source

Trial brachytherapy dose distribution

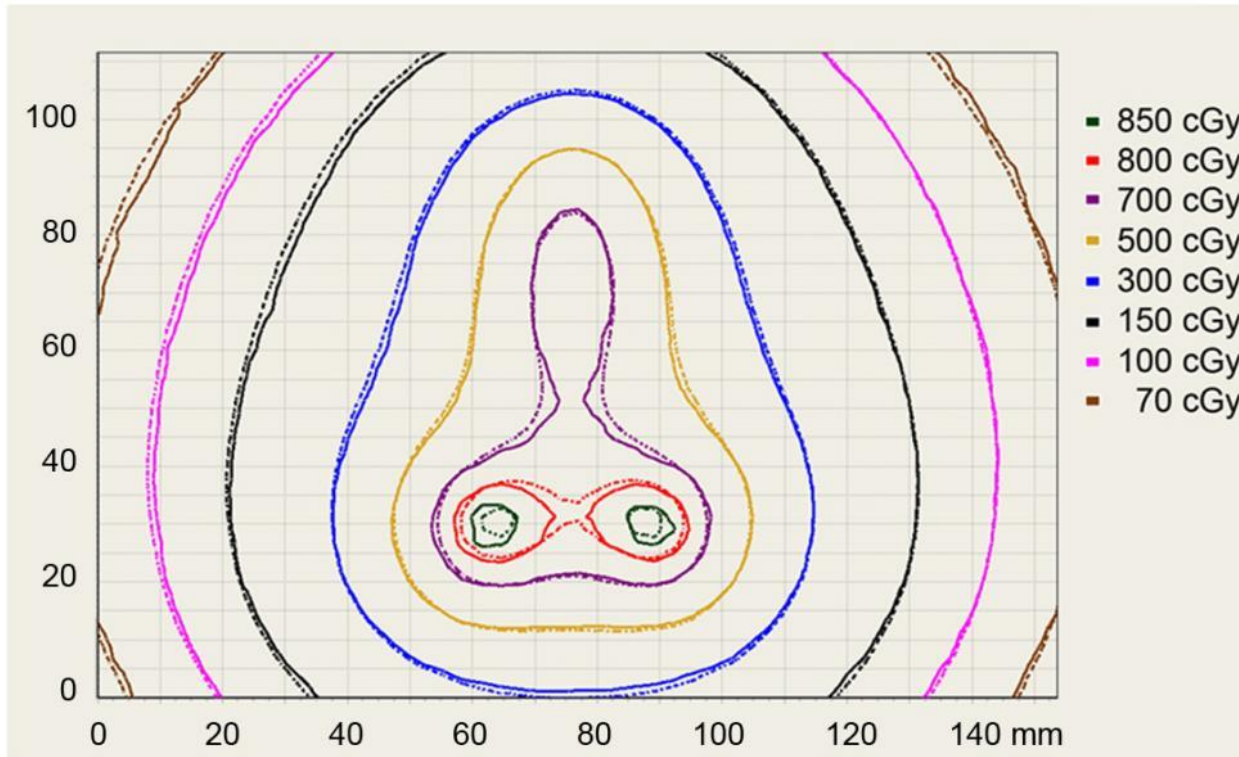

Isodose comparison,

dashed lines = treatment planning system (TPS) calculation,
thin lines = film-measured dose

Monte Carlo calculation EBT3 dosimetry

MCNP5 calculations to evaluate any perturbation of dose by film

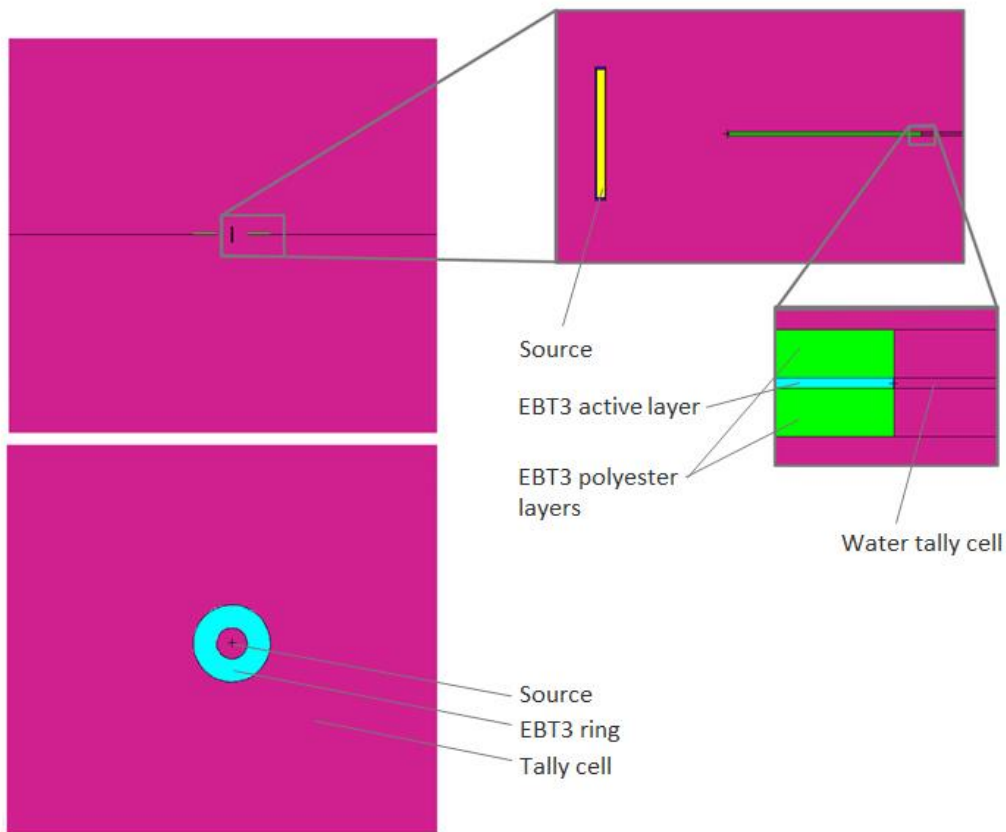

EBT3 side-on to
brachytherapy source

<0.1% dose
disturbance due to
presence of film over
15 mm film width

Design of test phantom

- ❑ Requirements
- ❑ Film phantom design
- ❑ Measurement methodology

Design requirements

- ❑ Securely hold any cervix gynaecology HDR brachytherapy treatment applicator
- ❑ Securely hold measurement film at known position from applicator
- ❑ Measurement at prescription point (Point A) and in clinically relevant regions (organs at risk: rectum, bladder)
- ❑ Resilience to positional error
- ❑ Two or more measurement planes

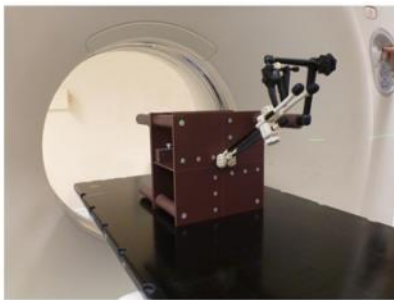

1. CT scan BRAD phantom with treatment applicator

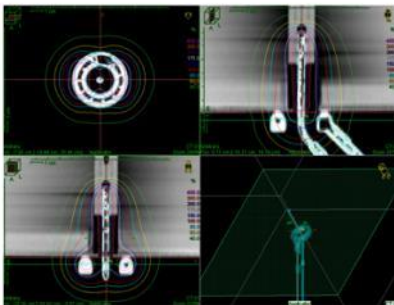

2. Generate clinical plan at treatment planning system

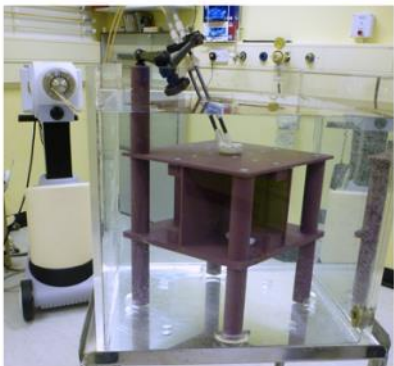

4. Deliver treatment plan to BRAD phantom, measure with film dosimeters

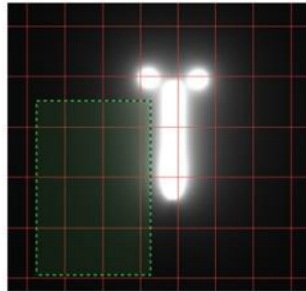

Planned treatment dose distribution



3. Export DICOM RTDose data (3D calculated dose map) from planning system



Good agreement

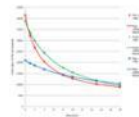

Actual delivered dose distribution



5. Calculate dose map from exposed film using triple-channel dosimetry

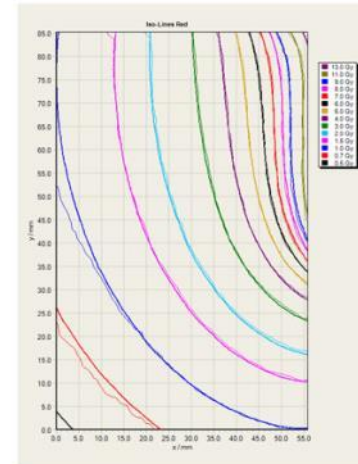

6. Compare intended planned dose distribution (RTDose) with actually delivered dose distribution (film measured)

'BRAD' film analysis

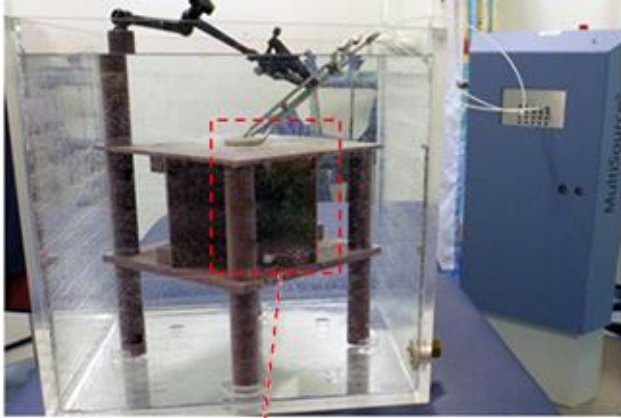

- Planned and delivered dose distributions compared via:
 - Prescription dose at Point A
 - Dose distribution comparison: isodose overlay and gamma analysis

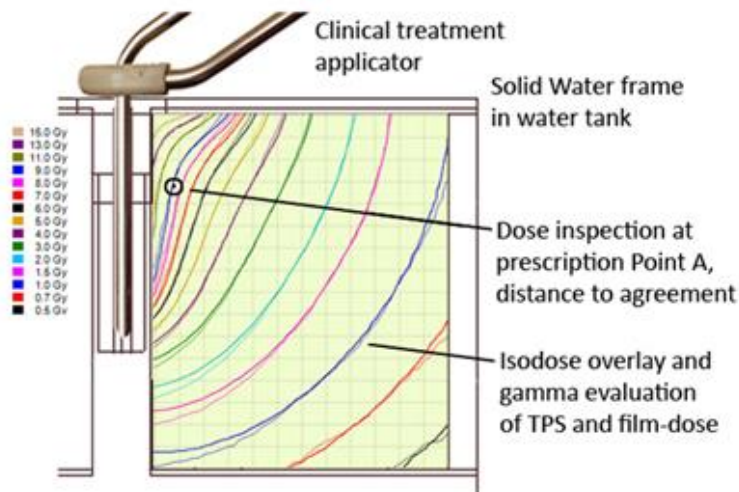

UK brachytherapy audit

- Scope
- Results
- Feedback

UK brachytherapy audit - scope

- ❑ Measurement of prescription point dose with film
- ❑ Comparison of planned and delivered dose distribution with film
- ❑ Discussion of local physics processes compared to UK 'average practice'

UK brachytherapy audit - scope

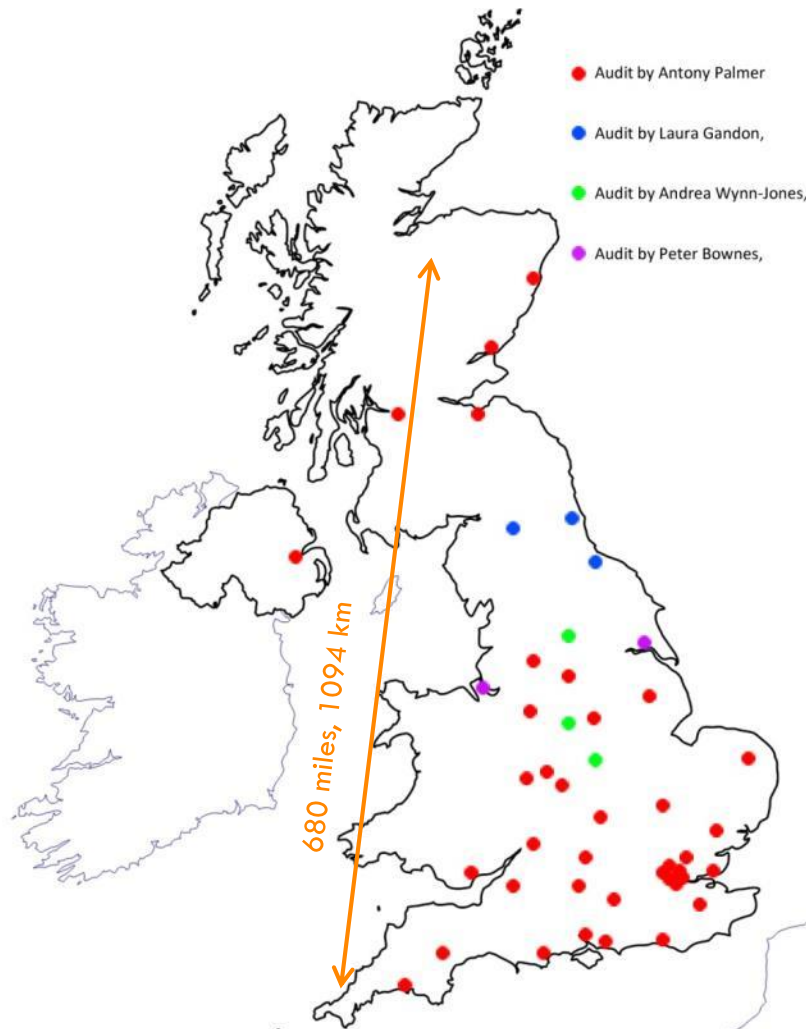

- 48 brachytherapy centres
- Audited between May 2013 and August 2014

Audit report

HDR Brachytherapy Audit Report

Brachytherapy
Applicator
Dosimetry

Hospital,

NHS Foundation Trust

Audit by: Tony Palmer, Portsmouth Hospitals NHS Trust, 11th November 2013
 Host centre lead: [redacted]

Summary

This audit was conducted using the brachytherapy applicator film dosimetry system (BRAD phantom) with an HDR treatment unit. The audit was conducted as a 'spot check' only and is not a comprehensive assessment of all possible treatment modes or equipment. This constitutes an assessment of one specific aspect of physics dosimetry alone, not any clinical aspects of treatment. The result is valid at the time of measurement only.

All results were satisfactory. Comparison of planning system calculated isodose distributions and the measured dose distributions from the HDR treatment unit and clinical treatment applicator showed acceptable agreement, with mean gamma passing rate of 96.5% at 3% (local), 2 mm criteria over a clinically relevant dose range. The treatment planning system (TPS) calculated dose for Manchester Point A was measured on the film dose maps within an average distance of 0.5 mm from the geometric position of Point A. Unusually, a locally defined 'Point C' is used in the TPS plan optimisation.

Method, materials and notes

The audit was conducted using the BRachytherapy Applicator Dosimetry ('BRAD') phantom utilising advanced radiochromic film dosimetry (Palmer *et al* 2013 *Phys. Med. Biol.* 58 6623-6640), for a UK national audit of brachytherapy dosimetry (funded by IPEM and under the auspices of IPEM RT-SIG), in combination with a supplementary measurement of source strength by RTTQA.

A Nucletron Interstitial Ring CT-MR applicator, 60 mm intrauterine (IU) tube, 30°, 30 mm ring (source to source diameter), was positioned within the BRAD phantom and CT scanned in approximate orientation for clinical use on a Philips Brilliance Big Bore scanner. CT scans were reconstructed at 1.0 mm slice width, consistent with local clinical brachytherapy protocols. A Nucletron Oncentra Brachy planning system (v 4.1.0.132) was used to manually locate dwell positions within the applicator using marker wire. No applicator library was available. Dwell positions were located along the centre of the applicator tubes in the ring and IU, with no path-corrections made for potential curvature-related displacements of the source. The local standard planning method was used. This includes a locally defined 'Point C', 7 mm lateral into tissue from the physical outside edge of the ring at the level of the centre of the source path, both left and right. All dwell positions in the IU were activated, and three dwells left and right each side of the ring. 7 Gy was prescribed to Point A, conventionally defined as 20 mm up from the physical ring surface and 20 mm lateral to IU, and then inverse planning used within the TPS to optimise dwells to deliver the prescription dose to Points A and Points C. An RTDose grid calculated at 1 mm resolution in each direction was exported and used for analysis. The plan was exported to the HDR treatment unit, Nucletron microSelectron HDR v2 with Ir-192 source, and four Gafchromic EBT3 films held within the BRAD phantom were irradiated through normal treatment delivery.

The measured film doses and exported planning system calculated RTDose matrix were compared using isodose overlay and gamma analysis. The dose at Point A was evaluated on each film and compared to TPS calculated dose for this point, and also the distance to agreement of the film measured dose to the TPS calculated dose at this point isodose was evaluated.

Results

Figure 1 shows isodose comparisons between TPS-calculated and film-measured doses for the four films held within the BRAD phantom. Table 1 provides gamma calculation passing rates for these situations.

The mean film measured dose at Point A was 6.85 Gy (at standard uncertainty estimate of 3.2%, k=1). The measured dose is therefore within 2.1% from the TPS calculated mean 7.00 Gy. Due to the sensitivity of the point dose to positional uncertainty (high dose gradients), it is suggested to use a distance to agreement indicator. The distance to agreement between the film measured dose and the TPS calculated dose at Point A was 0.5 mm for both lateral films (at a standard uncertainty of 0.6 mm, k=1).

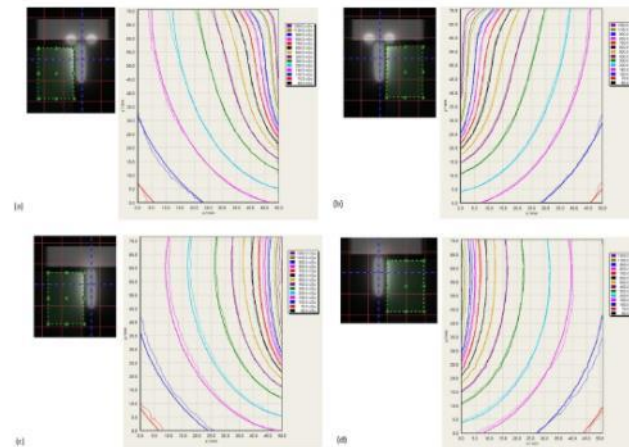

Figure 1. Isodose comparison between TPS-calculated and film-measured doses, over range 50 to 1300 cGy. RTDose plane and region of interest (50 x 70 mm) shown at left of isodose plot. (a) Right lateral through Point A, (b) left lateral through Point A, (c) anterior towards typical bladder, (d) posterior towards typical rectum.

Table 1. Gamma evaluation between TPS-calculated and film-measured dose distributions, over 50 x 70 mm regions of interest adjacent to the applicator, with 2 Gy lower cut-off. All percentage dose differences are locally normalised.

Film location in BRAD phantom	Gamma passing rate at:		
	5% (local) / 3 mm	3% (local) / 2 mm	2% (local) / 1.5 mm
Right lateral	99.2	97.3	87.8
Left lateral	99.3	96.2	89.6
Anterior	100.0	96.5	86.9
Posterior	100.0	95.8	80.7

UK brachytherapy audit - results

- Point A prescription dose

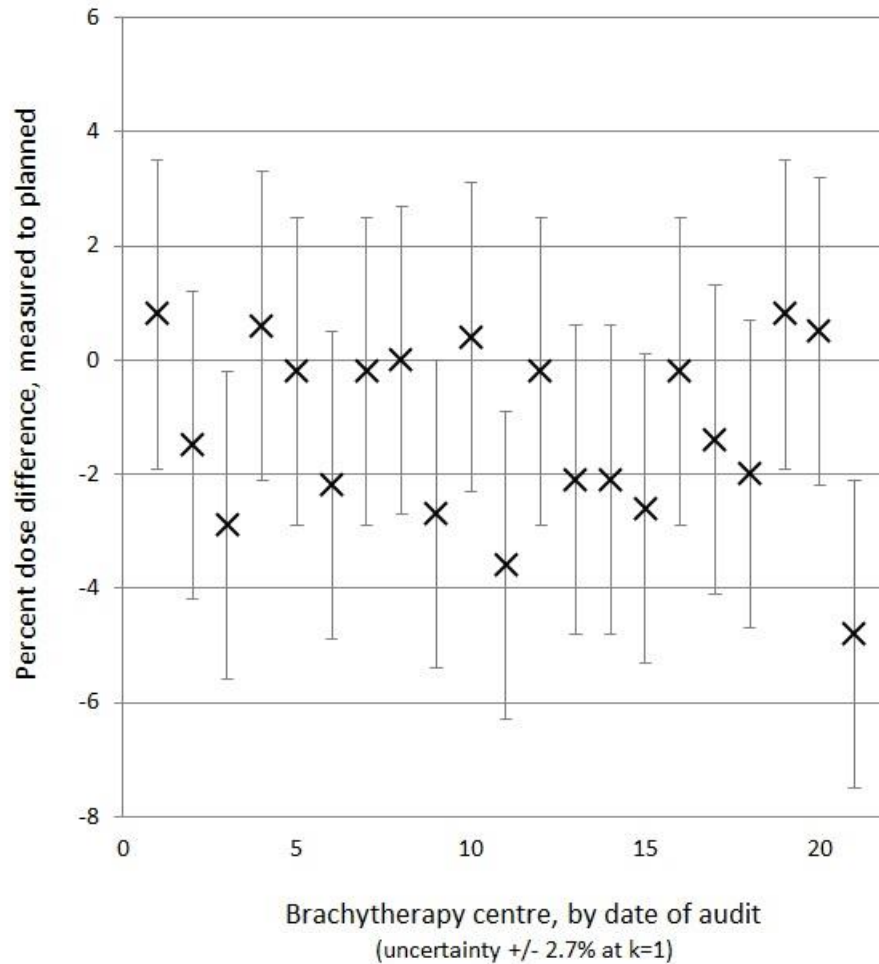

UK brachytherapy audit - results

- Point A prescription dose

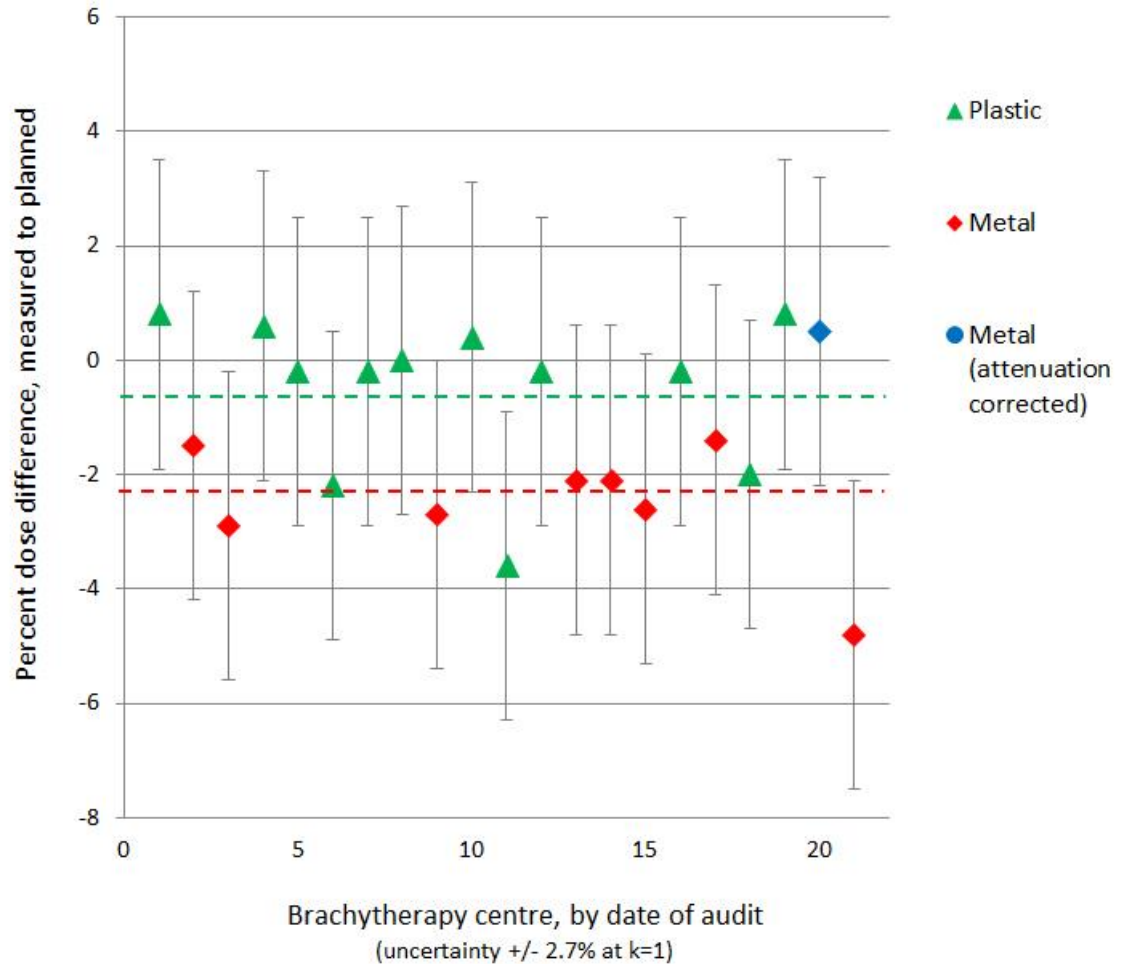

UK brachytherapy audit - results

□ Dose distribution

Gamma criteria:	5% (local), 3 mm	3% (local), 2 mm
Mean passing rate	99.8	98.1
Standard deviation	0.3	2.3

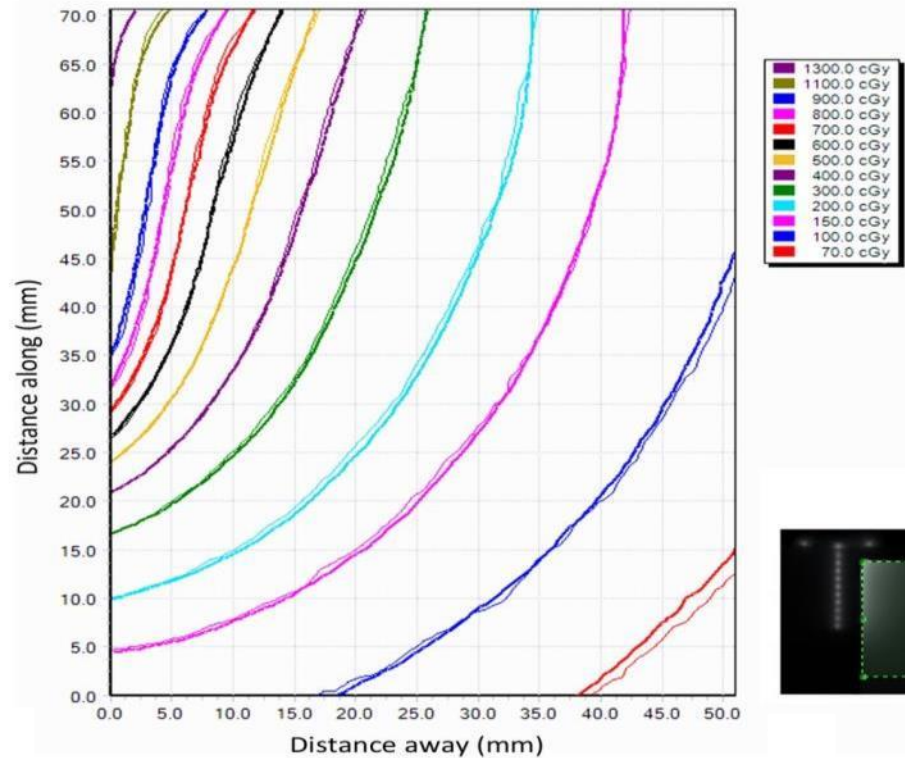

TPS library applicator alignment

Isodose comparison, thick lines = TPS, thin lines = film-dose

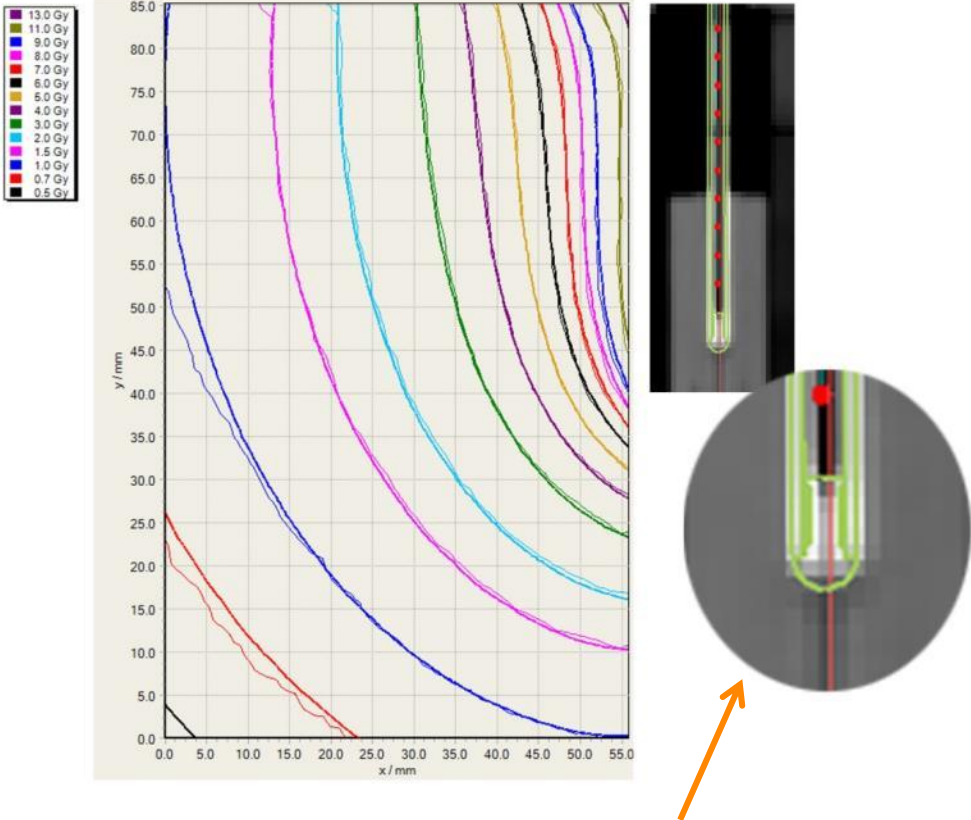

CT of treatment applicator in BRAD, with TPS applicator overlay (green) and first dwell point (red) – good alignment

TPS library applicator alignment

Isodose comparison, thick lines = TPS, thin lines = film-dose

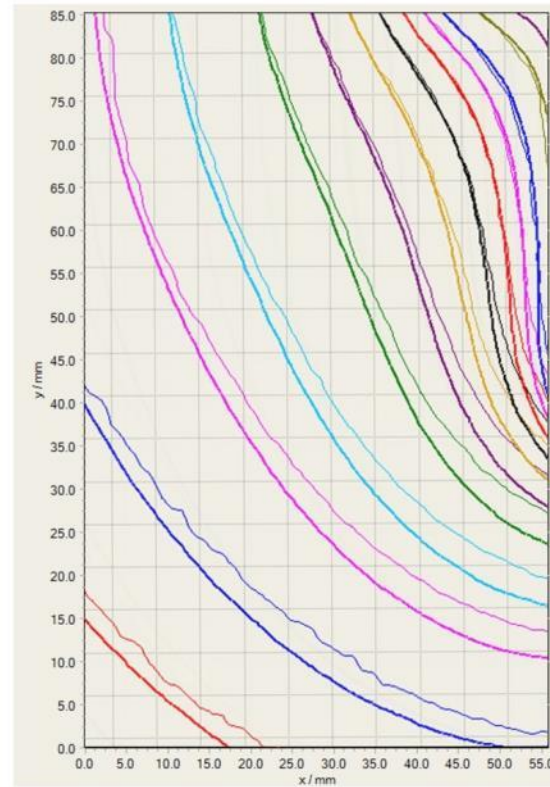
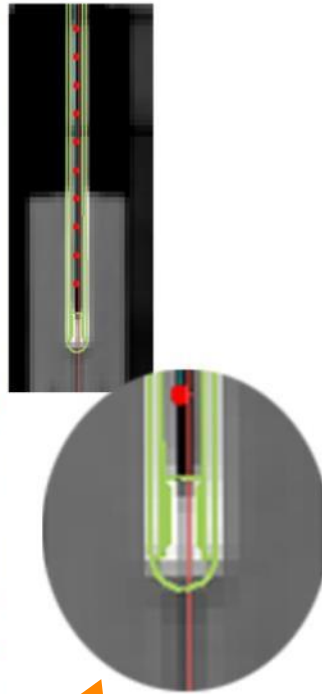
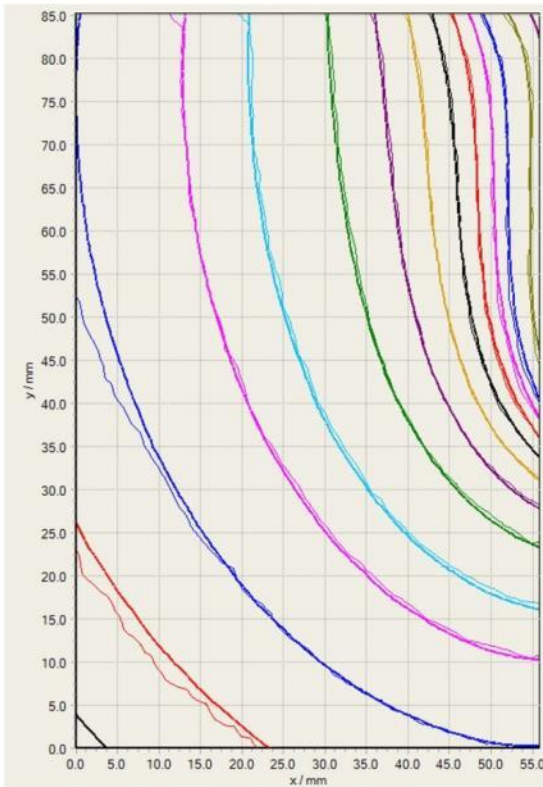

CT of treatment applicator in BRAD, with TPS applicator overlay (green) and first dwell point (red) – good alignment

TPS library applicator alignment

Isodose comparison, thick lines = TPS, thin lines = film-dose

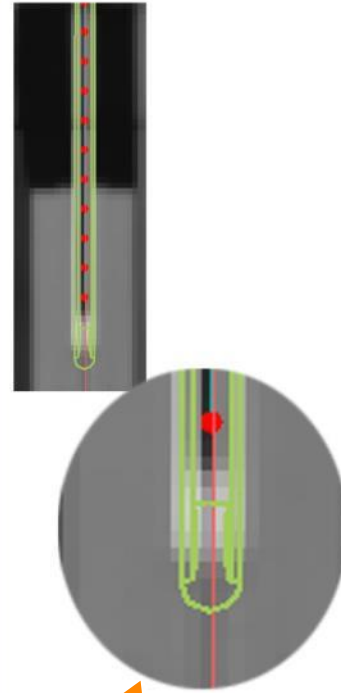
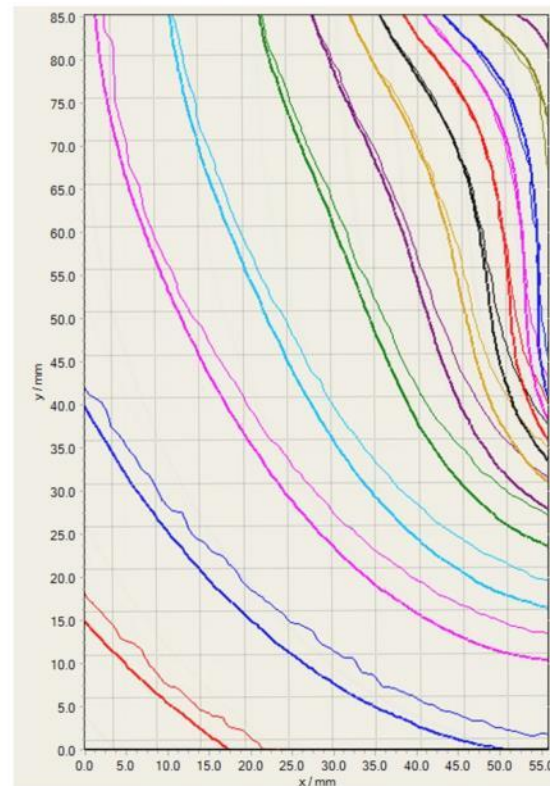
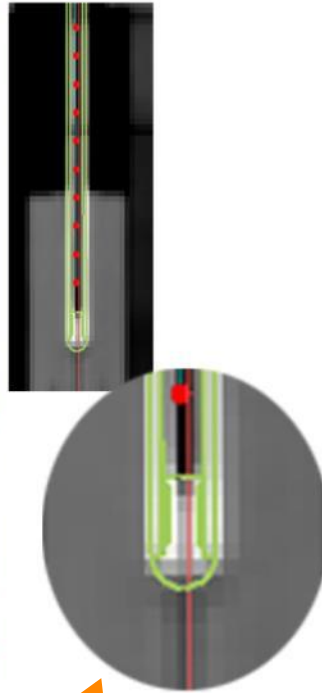
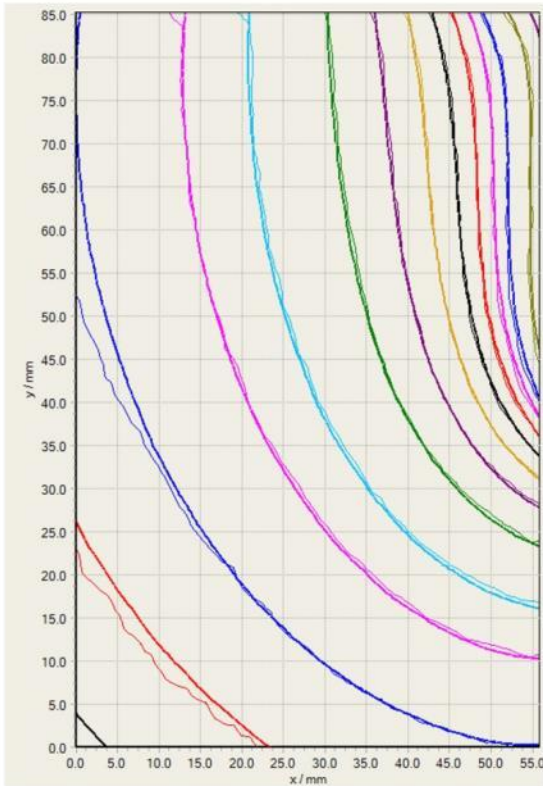

CT of treatment applicator in BRAD, with TPS applicator overlay (green) and first dwell point (red) – good alignment

Misalignment ~2 mm

TPS dose prescription

Dose Normalization, Optimization and Prescription

Normalization type: Normalized manual
F Factor: 1.000
Optimization type: Manual dwell weights / times
Optimization notification: Manually adjusted dwell weights / times.
Prescription dose per fraction/pulse (Gy): 7.0000
Total Reference Air Kerma per fraction/pulse at 1 m (Gy): 0.0000

Source Coordinates and Times (continued)

Catheter 2 (channel 5) - IU
Offset (cm): 0.00

Position	X (cm)	Y (cm)	Z (cm)	Dwell weight	Dwell time (sec.)
253	-0.07	0.55	20.55	3.10	374.9

Applicator Points

Set Name	Coord. System	Name	X (cm)	Y (cm)	Z (cm)	Abs. Dose (Gy)	Rel. Dose (%)
A-points	Applicator	A1	-2.00	2.00	0.00	10.2660	146.66
		A2	2.00	2.00	0.00	10.1457	144.94

...actually miscommunication on normalisation between auditor and local physicist....

Reminder of the 'human element' most prone to error

UK brachytherapy audit - results

- ❑ Local physics brachytherapy processes; in general good consensus of practice conforming to recommendations
- ❑ Some local practice issues noted, e.g.
 - ❑ Planning system applicator library different to physical applicator: length of IU and curvature
 - ❑ Clarity on distance between applicator tip and first dwell position
 - ❑ A few centres without an independent check method
 - ❑ Small differences in definition of prescription Point A
 - ❑ One incorrect normalisation of the plan, 'human error'

UK brachytherapy audit - feedback

- ❑ Typical feedback from audited centres:
 - ❑ “... simple audit and quick measurement method...”
 - ❑ “... quick results and good spatial resolution...”
 - ❑ “... access to a measurement method we had not previously used...”
 - ❑ “... it confirmed that our planning and delivery system is within acceptable clinical tolerances...”
 - ❑ “... found it reassuring to have our full process audited...”
 - ❑ “... I always believe any audit you pass is a very well set up and run audit...”

Conclusions

1

- ❑ First 'end-to-end' brachytherapy audit in UK
- ❑ Results surprisingly good; absolute point dose and dose distribution over large dose range
- ❑ Reassurance of high-quality UK practice
- ❑ A few improvement opportunities

Conclusions

2

- ❑ Full evaluation of Gafchromic EBT3 and triple-channel dosimetry in brachytherapy
- ❑ Film dosimetry provided method of measuring dose distribution in challenging scenario around clinical treatment applicators



Thanks:

Financial support from Ashland and IPEM,
Radiotherapy departments and brachytherapy physicists in UK,
Andy Nisbet and David Bradley

tony.palmer@porthosp.nhs.uk